



7520 EAST MAIN STREET, LIMA NY 14485  
 PH: 585-624-1990 - FAX: 585-624-2102  
 WEB: WWW.LAKELANDSCONCRETE.COM  
 E-MAIL: SALES@LAKELANDSCONCRETE.COM

DATE: 10/15/2020 DWG: CB242430

CATCH BASIN  
 2'-0" x 2'-0" x 2'-6"

**DESIGN CRITERIA:**

- CONCRETE: 5000 PSI @ 28 DAYS
- ENTRAINED AIR: 5% - 9%
- DESIGN LOADING: AASHTO HS20-44 WITH LESS THAN 2'-0" EARTH COVER
- REINFORCEMENT: BAR-ASTM A615 GR60  
WWR-ASTM A185

**SPECIFICATIONS:**

1. CUSTOM KNOCKOUTS OR OPENINGS ARE AVAILABLE UPON REQUEST
2. FIELD/FIELD ADJUSTMENT SIZED PER CUSTOMERS REQUEST
3. BITUMASTIC COATING AVAILABLE IF REQUIRED
4. BOOTS/LINK SEALS PROVIDED IF REQUIRED (LAKELANDS MUST BE NOTIFIED)
5. SUMPS AS NEEDED BY CUSTOMERS REQUEST
6. CUSTOMER TO GROUT ANY KEYWAYS AS REQUIRED
7. CUSTOMER IS RESPONSIBLE OF THE FRAME INSTALLATION IN FIELD (IF REQUIRED)

**\*\*MAXIMUM DEPTH TO BOTTOM OF CATCH BASIN = 10'-0" BELOW GRADE\*\***

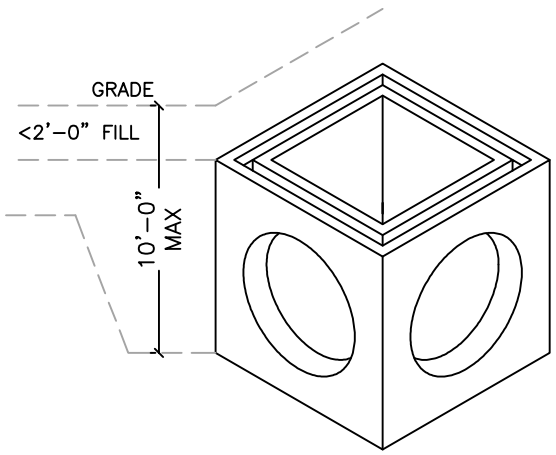

ISOMETRIC VIEW

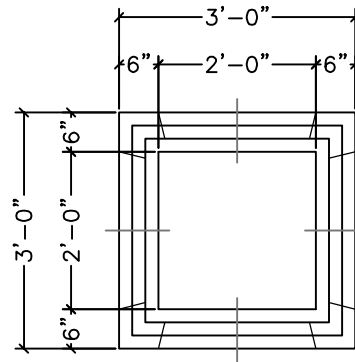

PLAN VIEW

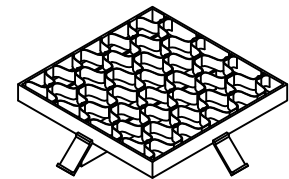

CAST-IN COLLAR FRAME AND GRATE

CAST-IN FRAME & GRATE  
 MODEL NO: \_\_\_\_\_  
 NOT NEEDED

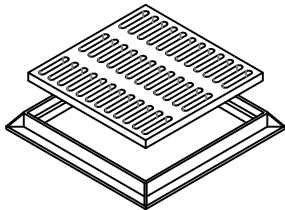

FRAME & GRATE

FRAME & GRATE  
 MODEL NO: \_\_\_\_\_  
 NOT NEEDED

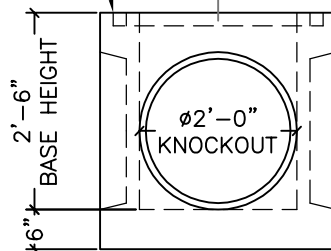
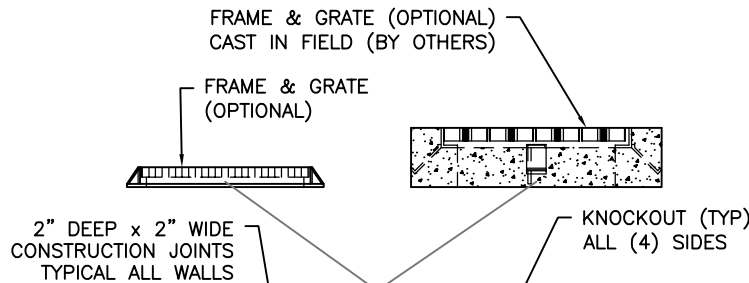

ELEVATION VIEW

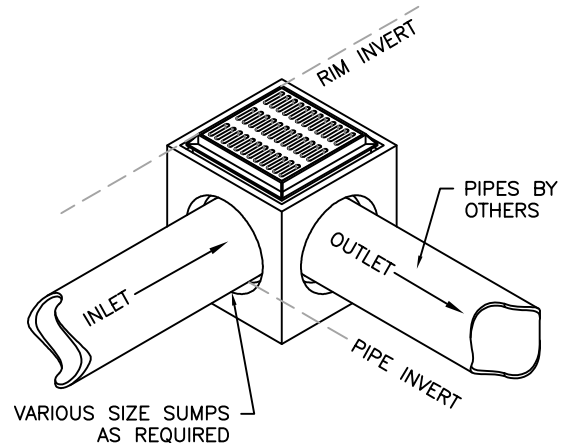

IN-FIELD VIEW

**BITUMASTIC COATING**

EXTERIOR  
 INTERIOR  
 EXTERIOR AND INTERIOR  
 NOT NEEDED

CATCH BASIN BASE HEIGHT	WEIGHT (LBS)
30"	2550